

WIRING: BACK VIEW OF CAMERA
1 = VIDEO / 2 = COM / 3 = 12 VOLT DC. (+)

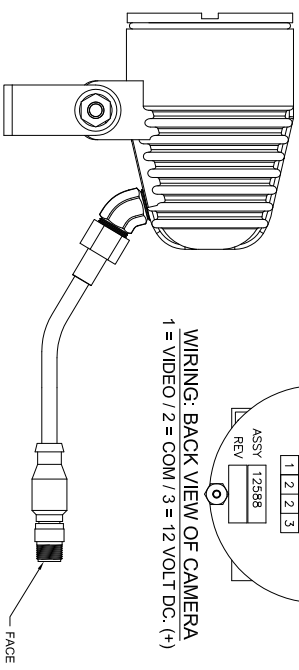

7030-34830-3
CAMERA T50 WATER TIGHT COLOR 3.6 MM. FORWARD VIEWING. RESOLUTION 380 LINES. 0.5 LUX. 12 VDC @ 120 MA WITH 5 PIN CONNECTOR PIGTAIL

7030-34830-4
CAMERA T50 WATER TIGHT COLOR 2.97 MM. REVERSE VIEWING. RESOLUTION 380 LINES. 0.5 LUX. 12 VDC @ 120 MA WITH 5 PIN CONNECTOR PIGTAIL

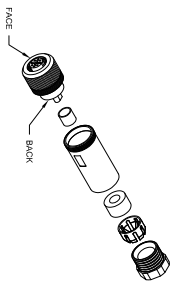

1032-33731: 5 Pin Female Straight Body Connector

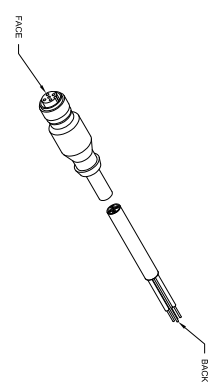
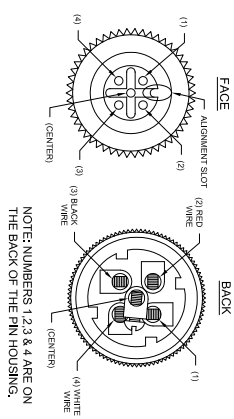

7030-34828-75 75 ft. Female Molded Cable & Connector Assembly

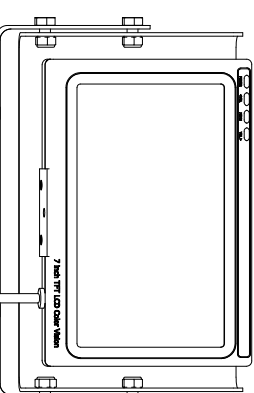
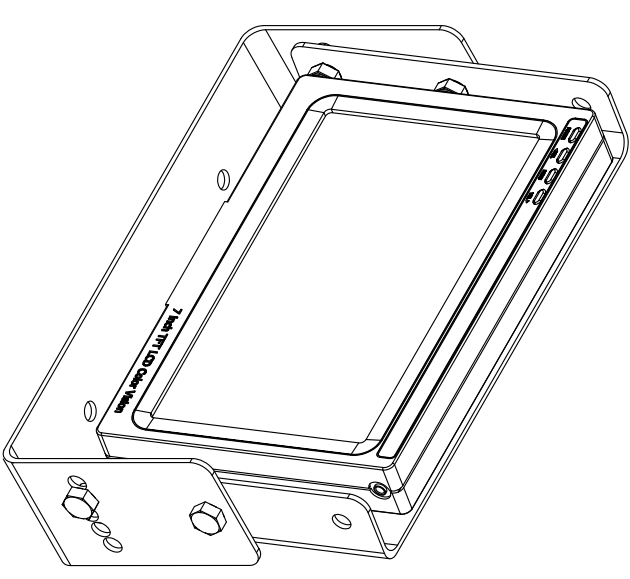
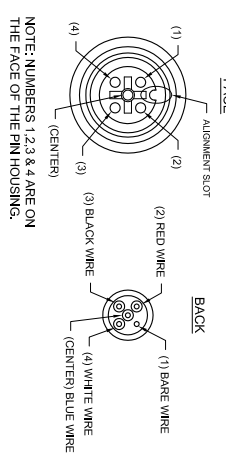

2023-34485-6
MONITOR / POWER SUPPLY ASSEMBLY 7 INCH. COLOR LCD WITH TWO CAMERA SYSTEM SWITCHING 12 VDC

1059-34534-25
MONITOR FOR 7" MONITOR WITH 2 CAMERAS AND REMOTE SWITCH

1032-33731
CONNECTOR 5 CONDUCTOR ST BODY FEMALE

7030-34828-75
75 FT. MOLDED CABLE & CONNECTOR ASSEMBLY FOR CAMERA SYSTEM

7030-34830-4

10 - 40 VDC 1 AMP. INPUT + WHITE - BLACK

2023-35600-1
WEATHER PAK CABLE ASSEMBLY (POWER END) 18'-2' SLOTTED 20' LONG

1059-34534-24
POWER SUPPLY ASSEMBLY 10 40 VDC IN LINE WITH WEATHER PAK CONNECTORS

1037-34348-61
WEATHER PAK PLUG ASSEMBLY

2023-35600-1

2023-35600-1

1037-34348-61
PLUG KIT

