

**MODEL 7030-33665-60 RIGHT HAND CONNECTIONS
MODEL 7030-33665-62 LEFT HAND CONNECTIONS
SINGLE 4" LCD MONITOR ENCLOSURE 12 VOLT DC
FOR UNDER GROUND USE WITH 5 PIN CONNECTORS**

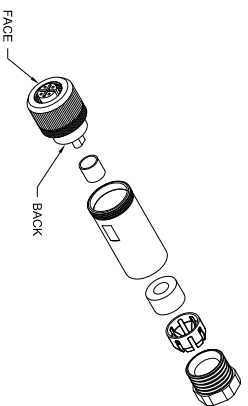

1032-33731 5 Pin Female Straight Body Connector

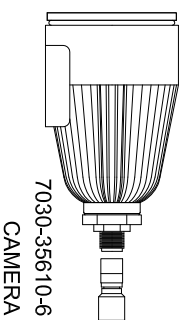
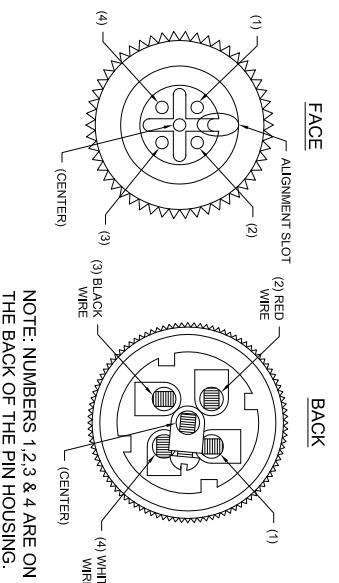

**7030-35610-6
CAMERA**

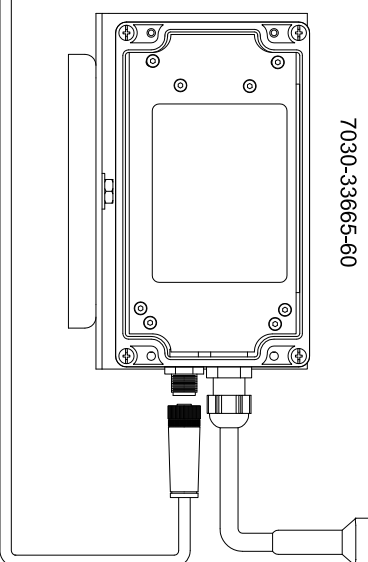
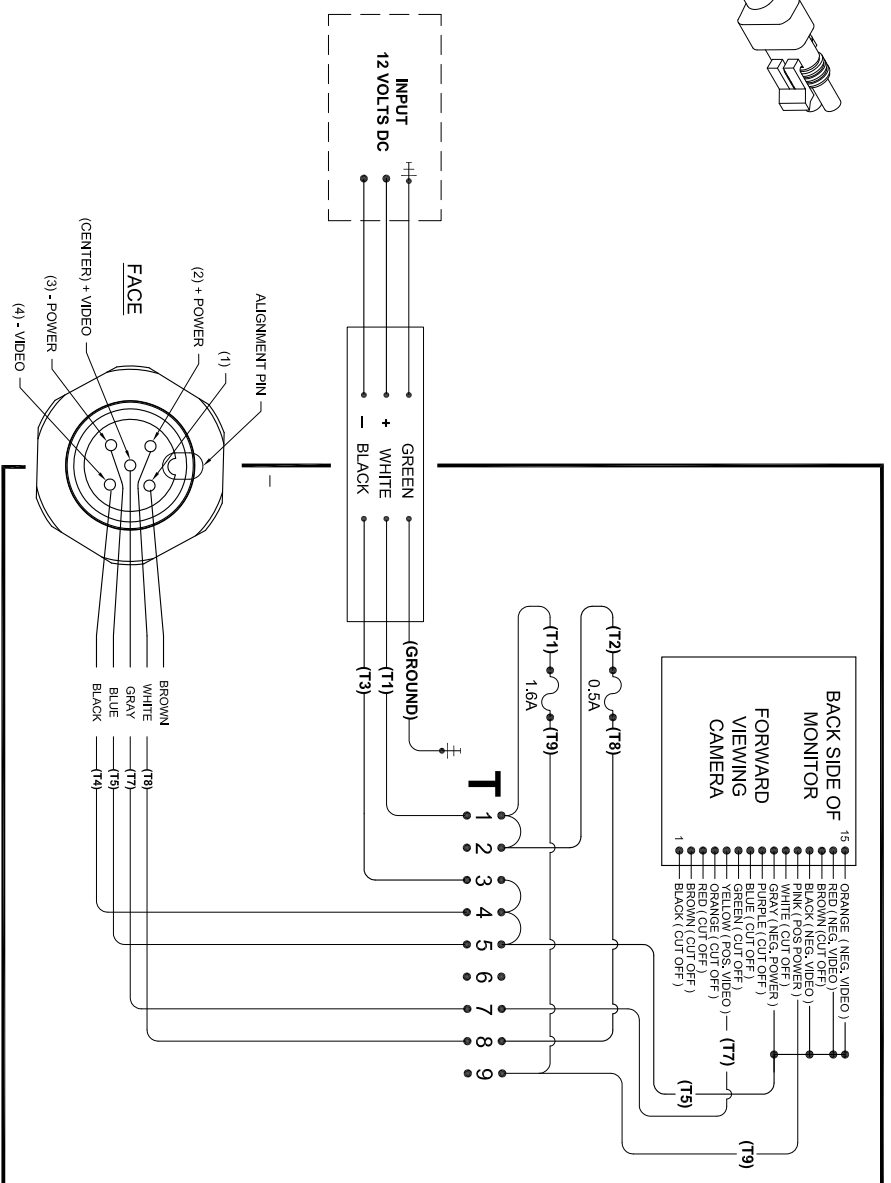

7030-33665-60

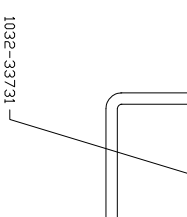

**7030-35610-6
CAMERA**

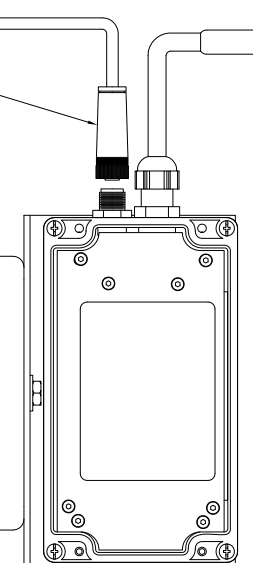

7030-33665-62

**12 VDC 1 AMP.
INPUT
+ WHITE
- BLACK**

2023-35600-1
WEATHER-PAK
CABLE ASSEMBLY
(POWER END)
18-2 SIDDW 20' LONG

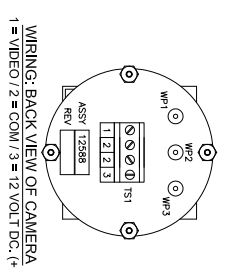

**WIRING: BACK VIEW OF CAMERA
1 = VIDEO / 2 = COM / 3 = 12 VOLT DC (1')**

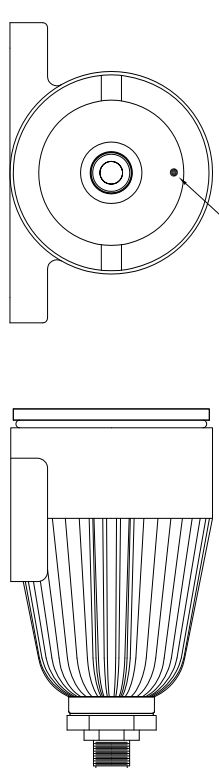
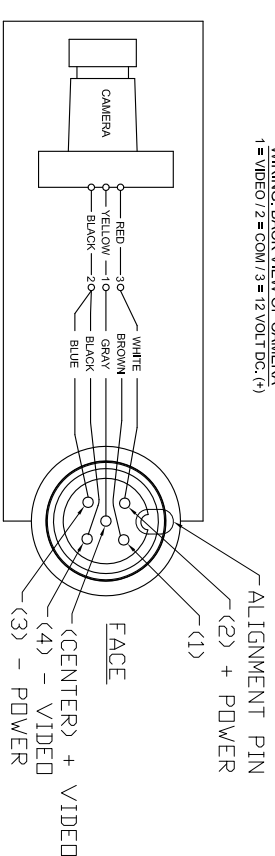

**7030-35610-6
CAMERA MCI 50 WATER TIGHT BLACK & WHITE 3.6 MM, FORWARD VIEWING, HIGH
RESOLUTION, 600 LINES, 0.0003 LUX, 12 VDC @ 100mA WITH 5 PIN CONNECTOR**

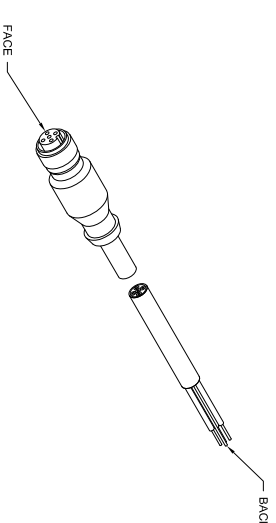

7030-34828-75 75 ft. Female Molded Cable & Connector Assembly

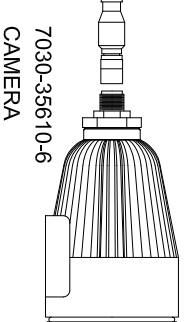
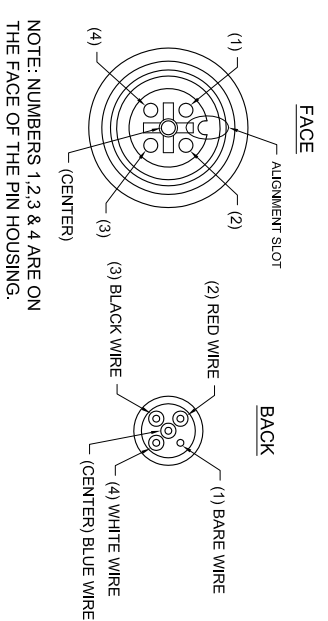

**7030-35610-6
CAMERA**